

GLS40



sal

LIGHTING

LS40FD

LS40 as professional luminaire, integrates with beautiful structure design, creative optical & thermal design, new material and intelligent control, can widely used for indoor general lighting.

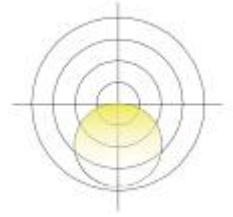

- AL6063-T5 aluminum profile with high-quality surface treatment and three optional colors of black/white/silver.
- LM80 certified light source, bridgelux LED, life >50000H
- Built-in efficient and safe flicker-free dimming power supply, Support 0-10V dimming or Dali dimming
- CRI 90+ option available

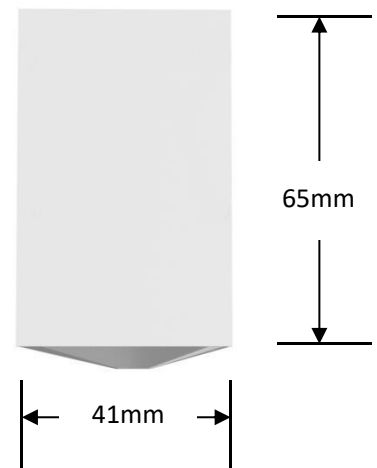

Optical & electronic data:

Model	Size	CCT	Flux (lm)	CRI	Beam angle	Input voltage	Dimming	PF	Power (w)	Efficiency (lm/w)
GLS-LS40FDXSS1200-T3 8NW8B-DC	1147mm	3000K	4130lm	>80	110°	200-240VAC 50Hz/60Hz	0-10V/ DALI	>0.9	38W	109
		3500K	4220lm							111
		4000K	4300lm							113
GLS-LS40FDXSS1500-T4 8NW8B-DC	1432mm	3000K	5160lm	>80	110°	200-240VAC 50Hz/60Hz	0-10V/ DALI	>0.9	48W	108
		3500K	5270lm							110
		4000K	5380lm							112
GLS-LS40FDXSS1800-T5 6NW8B-DC	1717mm	3000K	6200lm	>80	110°	200-240VAC 50Hz/60Hz	0-10V/ DALI	>0.9	56W	111
		3500K	6320lm							112
		4000K	6450lm							115
GLS-LS40FDXSS2300-T7 4NW8B-DC	2287mm	3000K	8260lm	>80	110°	200-240VAC 50Hz/60Hz	0-10V/ DALI	>0.9	74W	112
		3500K	8430lm							113
		4000K	8600lm							116

Remark:

- 1、 the output data is based on the testing result of 1.2m luminaires
- 2、 the tolerance of output data can be vary up to 10%;
- 3、 the output data is typical value;

◆ 1.2m luminaire with diffuser (GLS-LS40FD)

AAI Figure

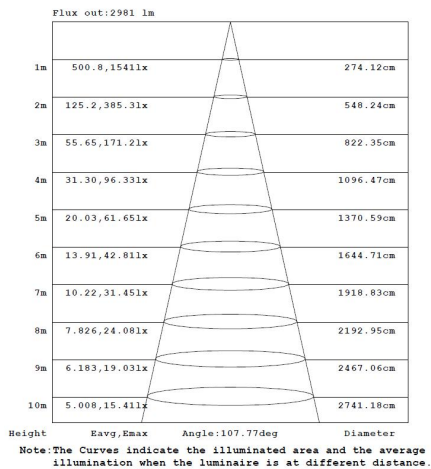

Luminous intensity distribution diagram

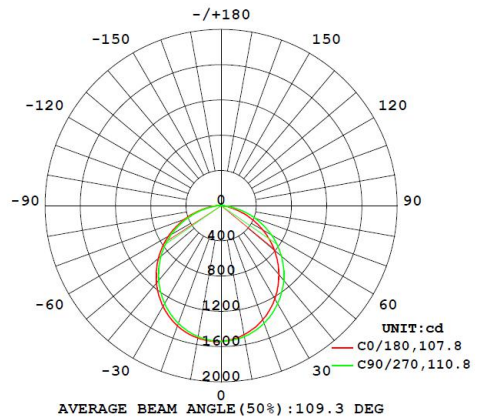

Packing:

◆The whole package

1. Tightly wrap and fix the magnetic endcaps and profiles with winding film (in order to prevent the plastic endcaps move and damaged by extrusion of profile), then put PE tube on the product.



2. The back of the product is placed on a 15 mm thick EPE FOAM, and with 22 mm thick EPE FOAMs at both ends, then stick EPE FOAM on the side, bundled with wrapping film;



3. Put the back of the product facing down on the W9K paper envelope with 3 mm thickness, and fold the paper envelope to wrap the product.

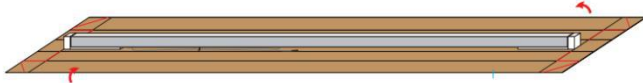

4. After the product is wrapped, the edge is sealed with adhesive paper and the product information labels are affixed.

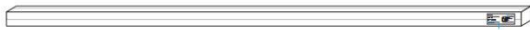

5. Put the white boxes packed with products in bundles according to the standard quantity and requirement. Add K = K paper sheath at both ends, then bundle them with wrapping film at both ends.



6. Pack the bundled products on K = K cardboard after indentation cutting.

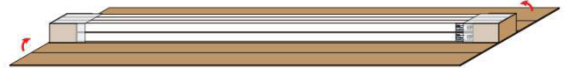

7. Sealing box with plastic corner guard, wrapping with film, then wrapping with packaging tape.

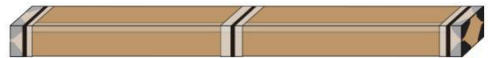

8. Labeling (SEL Label, Quantity, Net Weight, Gross Weight Labels, Box Seal)

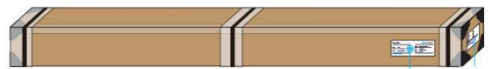

Model	Type	Demension (individual package)	Pcs /bundle	NW (Kg)	GW (Kg)	Demension (whole package)	CBM (m ³)
GLS-LS40FDXSS1200-T38XX8B-DC	Individual Packing	1195*110*55mm	6	11.16	14.84	1270*240*185mm	0.06
GLS-LS40FDXSS1500-T48XX8B-DC		1495*110*55mm	6	13.95	18.55	1570*240*185mm	0.07
GLS-LS40FDXSS1800-T56XX8B-DC		1764*110*55mm	6	16.74	22.26	1840*240*185mm	0.08
GLS-LS40FDXSS2400-T74XX8B-DC		2364*110*55mm	6	22.32	29.68	2440*240*185mm	0.11

◆ Description about label information

GLS-LS70		sel LIGHTING	
Luminous flux:	190 OLM	Type:	Luminaire
Power(Typ):	18W	Part NO:	GLS-LS70DAHES-18W8N-LC
CCT:	6000K	SO:	YO17050147
CRI:	>80	NO:	ZWL170510-0380
Input voltage:	100-277VAC	Color:	Silver
Frequency:	50/60Hz	Power factor:	>0.95
		Cover type:	UGR filter diffuser
		Size:	73x80x1210mm
		Date:	20181220
Terminal block not included. Installation must be performed by a qualified person.			

Ordering code:

Category	Installation	Section Size	Diffuser Shape	Diffuser Nature	Carrier Style	Profile Color	End Cap Style	Length	-Light Source Type	Type Power of Luminaire	CCT	CRI	Power Type	Package	Label Type		
General Lighting System	Pendant	40 Series	Flat	Diffuser	No Carrier	White	Standard End Cap	1147mm	-Constant Current Rigid	38W	3000K	CRI>80	0-10V	Individual Packing	SEL		
GLS	-LS	40	F	D	X	W	S	1200	-T	38	3500K	8	DALI	-D	L		
						Black		1432mm		48W					B	Customized	
						B		1500		48					A	S	
						Silver		1717mm		56W							
						S		1800		56							PW
								2287mm		74W							4000K
2300	74	NW															
GLS	-LS	40	F	D	X	W	S	1200	-T	38	NW	8	B	-D	L		

Attentions:

- ◆ Please install the product in the right environment as much as possible;
- ◆ Please be careful during operation. Do not touch the AC power supply in case of electric shock;
- ◆ Check the current through the circuit, such as the surge occurs when press the switch does not exceed the maximum rated current, please insert the appropriate protection circuit;
- ◆ This product is sensitive to static electricity, and please special attention. In particular, it will damage the product when the static electricity is more than absolute maximum rated current and voltage, please make a countermeasures to avoid the damage of the static electricity and surge when using the product.